



Type B double-wall common vent

Connector rise  $R$

Type B double-wall gas vent used as connectors

Manifold common vent connector

Connectors

AMERICAN METAL<sup>®</sup>  
PRODUCTS GROUP

VENTING GUIDELINES FOR CATEGORY I GAS APPLIANCES

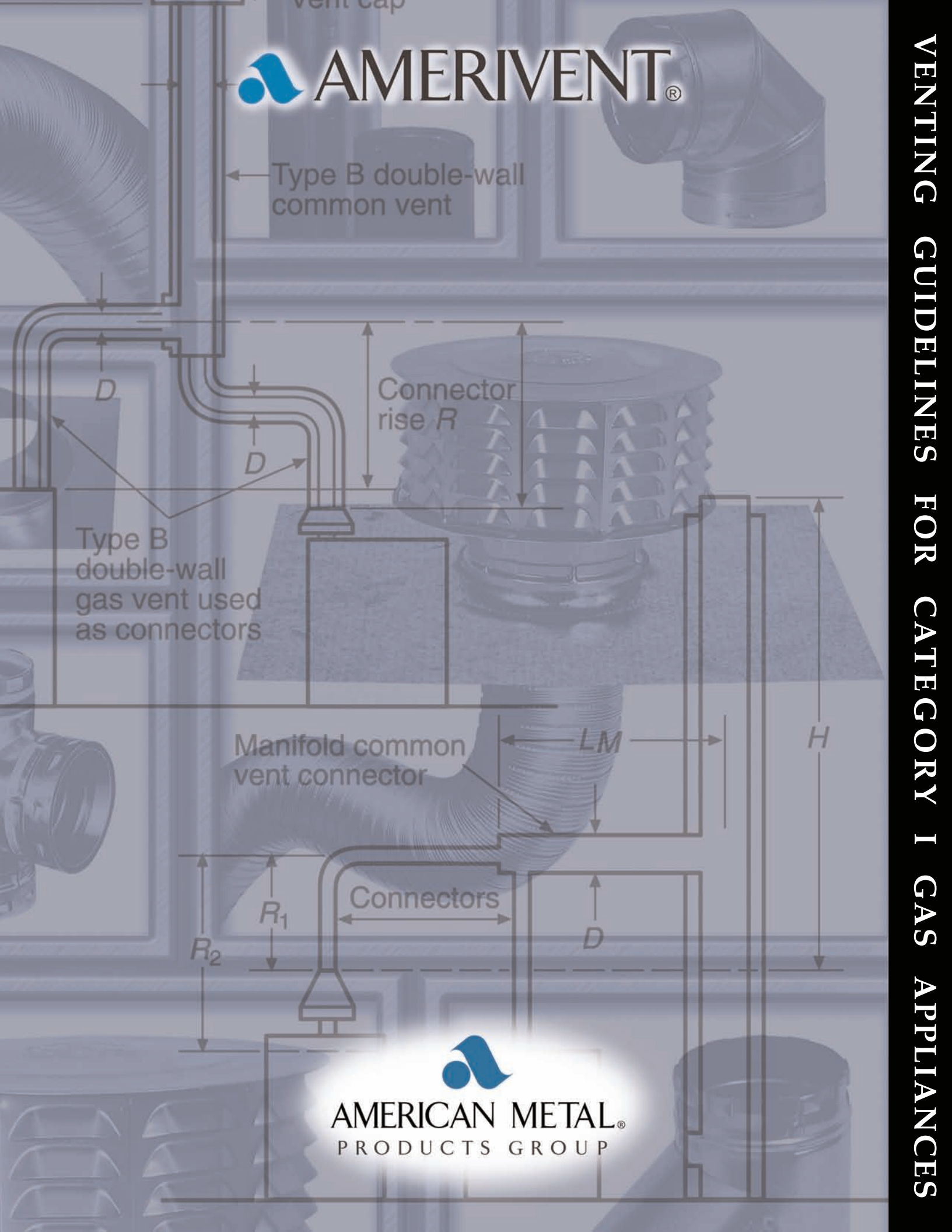

Introduction .....2

Definitions .....3

**I. Single Appliances .....3**

    Notes for Single-Appliance Vent - Tables 1 and 2 .....3

    Table 1 - Single Appliance  
    *(Capacity of Type B Double-Wall Vents when Connected Directly to a Single Appliance)* .....6

    Table 2 - Single Appliance  
    *(Capacity of Type B Double-Wall Vents with Single Metal Connectors)* .....8

    Examples Using Single-Appliance Venting Tables .....10

**II. Two or More Appliances .....12**

    Notes for Two or More Appliances - Tables 3 and 4 .....12

    Table 3 - Two or More Appliances  
    *(Capacity of Type B Double-Wall Vents with Type B Double-Wall Connectors Serving Two or More Category I Appliances)* .....16

    Table 4 - Two or More Appliances  
    *(Capacity of Type B Double-Wall Vents with Single-Wall Connectors Serving Two or More Category I Appliances)* .....18

    Examples Using Common Venting Tables .....19

## Introduction

The vent sizing tables in this brochure are part of the National Fuel Gas Code. These tables cover vent sizing for both fan-assisted combustion and draft hood-equipped appliances.

Vents for most draft hood-equipped appliances can still be sized based on the draft hood outlet size, or they can be sized using the tables or other engineered methods. However, when installing Category I fan-assisted combustion furnaces, the **tables or other engineered methods must be used**.

In addition, the tables for fan-assisted combustion appliances have *minimum* as well as *maximum* rates. These appliances generally have lower flue gas temperatures and less dilution air, and therefore have an increased chance of continuous condensation if the vent is too large.

These vent sizing tables cannot be used for vented wall furnaces, decorative appliances, or room heaters. The appliance manufacturer's venting instructions should be checked to make sure which sizing method is recommended.

Additional references for the development of the material in this Guide were taken with permission from the following.

National Fuel Gas Code, NFPA Standard 54 ANSI Z223.1

The capacities given in the tables for Type B Gas Vent are consistent with those found in publications by the appliance manufacturers and NFPA 54 National Fuel Gas Code.

For information on products to use with the systems designed by use of this Guide, refer to the various specific product literature.

**NOTE:** This Guide should be used in addition to, not as a replacement for, American Metal Products Group's installation instructions. Always read and comply with the manufacturer's installation instructions supplied with the appliance.

## Definitions

1. **Appliance Categorized Vent Diameter/Area** — The minimum vent area/diameter permissible for Category I appliances to maintain a nonpositive vent static pressure when tested in accordance with nationally recognized standards.
2. **Fan-Assisted Combustion System** — An appliance equipped with an integral mechanical means to either draw or force products of combustion through the combustion chamber or heat exchanger.
3. **FAN Max** — The maximum input rating of a Category I, fan-assisted appliance attached to a vent or connector.
4. **FAN Min** — The minimum input rating of a Category I, fan-assisted appliance attached to a vent or connector.
5. **FAN+FAN** — The maximum combined appliance input rating of two or more Category I, fan-assisted appliances attached to the common vent.
6. **FAN+NAT** — The maximum combined appliance input rating of one or more Category I, fan-assisted appliances and one or more Category I, draft hood-equipped appliances attached to the common vent.
7. **NA** — Vent configuration is not permitted due to potential for condensate formation or pressurization of the venting system, or not applicable due to physical or geometric restraints.
8. **NAT Max** — The maximum input rating of a Category I, draft hood-equipped appliance attached to a vent or connector.
9. **NAT+NAT** — The maximum combined appliance input rating of two or more Category I draft hood-equipped appliances attached to the common vent.

---

## Single-Appliance Vent - Tables 1 and 2

### Notes for Single-Appliance Vent

1. These venting tables shall not be used where heat reclaimers, draft regulators and vent dampers are installed in the venting system.
  - a) The maximum capacity of the vent system shall be determined using the “NAT Max” column.
  - b) The minimum capacity shall be determined as if the appliance were a fan-assisted appliance, using the “FAN Min” column to determine the minimum capacity of the vent system. Where the corresponding “Fan Min” is “NA,” the vent configuration shall not be permitted, and an alternative venting configuration shall be utilized.
2. If the vent size determined from the tables is smaller than the appliance draft hood outlet or flue collar, the smaller size shall be permitted to be used, provided the following requirements are met.
  - a) The total vent height (H) is at least 10 feet (3 m).
  - b) Vents for appliance draft hood outlets or flue collars 12 inches (300 mm) in diameter or smaller are not reduced more than one table size.
  - c) Vents for appliance draft hood outlets or flue collars larger than 12 inches (300 mm) in diameter are not reduced more than two table sizes.
  - d) The maximum capacity listed in the tables for a fan-assisted appliance is reduced by 10 percent (0.90 maximum table capacity).
  - e) The draft hood outlet is greater than 4 inches (100 mm) in diameter. Do not connect a 3-inch (80 mm) diameter vent to a 4-inch (100 mm) diameter draft hood outlet. This provision shall not apply to fan-assisted appliances.

Single-Appliance Vent - Tables 1 and 2 (continued)

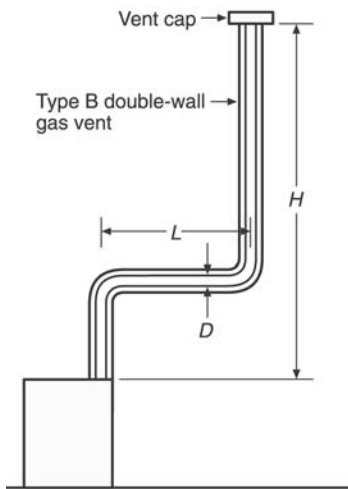

Figure 1

Table 1 is used when sizing Type B double-wall gas vent connected directly to the appliance.

Note: The appliance type may be either Category I draft hood-equipped or fan-assisted.

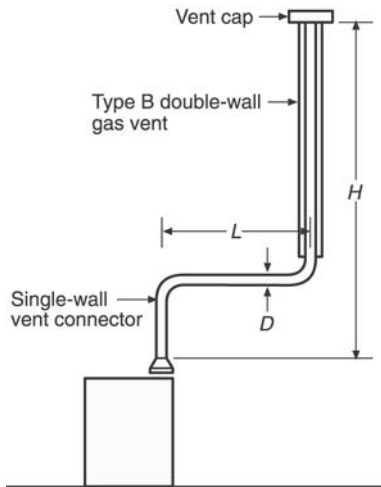

Figure 2

Table 2 is used when sizing a single-wall metal vent connector attached to a Type B double-wall gas vent.

Note: The appliance type may be either Category I draft hood-equipped or fan-assisted.

3. Single-appliance venting configurations with zero (0) lateral lengths in **Tables 1 and 2** shall have no elbows in the venting system. For vent configurations with lateral lengths, the venting tables include allowance for two 90-degree turns. For each additional 90-degree turn, or equivalent, the maximum capacity listed in the venting tables shall be reduced by 10 percent (0.90 x maximum table capacity). Two or more turns, the combined angles of which equal 90 degrees, shall be considered equivalent to one 90-degree turn.  
**Note:** Two 45-degree turns are equivalent to one 90-degree turn.
4. Zero (0) lateral (L) shall apply only to a straight vertical vent attached to a top outlet draft hood or flue collar.
5. Sea-level input ratings shall be used when determining maximum capacity for high-altitude installation. Actual input (derated for altitude) shall be used for determining minimum capacity for high-altitude installation.
6. For appliances with more than one input rate, the minimum vent capacity (FAN Min) determined from the tables shall be less than the lowest appliance input rating, and the maximum vent capacity (FAN Max/NAT Max) determined from the tables shall be greater than the highest appliance rating input.
7. Listed corrugated metallic chimney liner systems in masonry chimneys shall be sized by using **Table 1 or 2** for Type B vents, with the maximum capacity reduced by 20 percent (0.80 maximum capacity) and the minimum capacity as shown in **Table 1 or 2**. Corrugated metallic liner systems installed with bends or offsets shall have their maximum capacity further reduced in accordance with **Paragraph 3**.
8. If the vertical vent has a larger diameter than the vent connector, the vertical vent diameter shall be used to determine the minimum vent capacity, and the connector diameter shall be used to determine the maximum vent capacity. The flow area of the vertical vent shall not exceed seven times the flow area of the listed appliance categorized vent area, flue collar area, or draft hood outlet area, unless designated in accordance with approved engineering methods.
9. **Tables 1 and 2** shall be used for chimneys and vents not exposed to the outdoors below the roof line. A Type B vent or listed chimney lining system passing through an unused masonry chimney flue shall not be considered to be exposed to the outdoors.

## Single-Appliance Vent - Tables 1 and 2 (continued)

10. Vent connectors shall not be upsized more than two sizes greater than the listed appliance categorized vent diameter, flue collar diameter, or draft hood outlet diameter.
11. In a single run of vent or vent connector, more than one diameter and type shall be permitted to be used, provided that all the sizes and types are permitted by the tables.
12. Interpolation shall be permitted in calculating capacities for vent dimensions that fall between table entries. (See **Example 3**.)
13. Extrapolation beyond the table entries shall not be permitted.  
For SI units, 1 inch = 25.4 mm; 1 foot = 0.305 m; 1000 Btu/hour = 0.293 kW; 1 inch<sup>2</sup> = 645 mm<sup>2</sup>.
14. For vent heights lower than 6 feet and higher than shown in the tables, engineering methods shall be used to calculate vent capacities.

**Table 1 - Single Appliance**

**Capacity of Type B Double-Wall Vents  
when connected directly to a Single Category I Appliance**

Height <i>H</i> (ft.)	Lateral <i>L</i> (ft.)	Vent Diameter - <i>D</i>																					
		3 in.			4 in.			5 in.			6 in.			7 in.			8 in.			9 in.			
		Appliance Input Rating in Thousands of Btu per Hour																					
		FAN			NAT			FAN			NAT			FAN			NAT			FAN			NAT
Min	Max	Max	Min	Max	Max	Min	Max	Max	Min	Max	Max	Min	Max	Max	Min	Max	Max	Min	Max	Max	Min	Max	Max
6	0	0	78	46	0	152	86	0	251	141	0	375	205	0	524	285	0	698	370	0	897	470	
	2	13	51	36	18	97	67	27	157	105	32	232	157	44	321	217	53	425	285	63	543	370	
	4	21	49	34	30	94	64	39	153	103	50	227	153	66	316	211	79	419	279	93	536	362	
	6	25	46	32	36	91	61	47	149	100	59	223	149	78	310	205	93	413	273	110	530	354	
8	0	0	84	50	0	165	94	0	276	155	0	415	235	0	583	320	0	780	415	0	1006	537	
	2	12	57	40	16	109	75	25	178	120	28	263	180	42	365	247	50	483	322	60	619	418	
	5	23	53	38	32	103	71	42	171	115	53	255	173	70	356	237	83	473	313	99	607	407	
	8	28	49	35	39	98	66	51	164	109	64	247	165	84	347	227	99	463	303	117	596	396	
10	0	0	88	53	0	175	100	0	295	166	0	447	255	0	631	345	0	847	450	0	1096	585	
	2	12	61	42	17	118	81	23	194	129	26	289	195	40	402	273	48	533	355	57	684	457	
	5	23	57	40	32	113	77	41	187	124	52	280	188	68	392	263	81	522	346	95	671	466	
	10	30	51	36	41	104	70	54	176	115	67	267	175	88	376	245	104	504	330	122	651	427	
15	0	0	94	58	0	191	112	0	327	187	0	502	285	0	716	390	0	970	525	0	1263	682	
	2	11	69	48	15	136	93	20	226	150	22	339	225	38	475	316	45	633	414	53	815	544	
	5	22	65	45	30	130	87	39	219	142	49	330	217	64	463	300	76	620	403	90	800	529	
	10	29	59	41	40	121	82	51	206	135	64	315	208	84	445	288	99	600	386	116	777	507	
	15	35	53	37	48	112	76	61	195	128	76	301	198	98	429	275	115	580	373	134	755	491	
20	0	0	97	61	0	202	119	0	349	202	0	540	307	0	776	430	0	1057	575	0	1384	752	
	2	10	75	51	14	149	100	18	250	166	20	377	249	33	531	346	41	711	470	50	917	612	
	5	21	71	48	29	143	96	38	242	160	47	367	241	62	519	337	73	697	460	86	902	599	
	10	28	64	44	38	133	89	50	229	150	62	351	228	81	499	321	95	675	443	112	877	576	
	15	34	58	40	46	124	84	59	217	142	73	337	217	94	481	308	111	654	427	129	853	557	
	20	48	52	35	55	116	78	69	206	134	84	322	206	107	464	295	125	634	410	145	830	537	
30	0	0	100	64	0	213	128	0	374	220	9	587	336	0	853	475	0	1173	650	0	1548	855	
	2	9	81	56	13	166	112	14	283	185	18	432	280	27	613	394	33	826	535	42	1072	700	
	5	21	77	54	28	160	108	36	275	176	45	421	273	58	600	385	69	811	524	82	1055	688	
	10	27	70	50	37	150	102	48	262	171	59	405	261	77	580	371	91	788	507	107	1028	668	
	15	33	64	NA	44	141	96	57	249	163	70	389	249	90	560	357	105	765	490	124	1002	648	
	20	56	58	NA	53	132	90	66	237	154	80	374	237	102	542	343	119	743	473	139	977	628	
	30	NA	NA	NA	73	113	NA	88	214	NA	104	346	219	131	507	321	149	702	444	171	929	594	
50	0	0	101	67	0	216	134	0	397	232	0	633	363	0	932	518	0	1297	708	0	1730	952	
	2	8	86	61	11	183	122	14	320	206	15	497	314	22	715	445	26	975	615	33	1276	813	
	5	20	82	NA	27	177	119	35	312	200	43	487	308	55	702	438	65	960	605	77	1259	798	
	10	26	76	NA	35	168	114	45	299	190	56	471	298	73	681	426	86	935	589	101	1230	773	
	15	59	70	NA	42	158	NA	54	287	180	66	455	288	85	662	413	100	911	572	117	1203	747	
	20	NA	NA	NA	50	149	NA	63	275	169	76	440	278	97	642	401	113	888	556	131	1176	722	
	30	NA	NA	NA	69	131	NA	84	250	NA	99	410	259	123	605	376	141	844	522	161	1125	670	
100	0	NA	NA	NA	0	218	NA	0	407	NA	0	665	400	0	997	560	0	1411	770	0	1908	1040	
	2	NA	NA	NA	10	194	NA	12	354	NA	13	566	375	18	831	510	21	1155	700	25	1536	935	
	5	NA	NA	NA	26	189	NA	33	347	NA	40	557	369	52	820	504	60	1141	692	71	1519	926	
	10	NA	NA	NA	33	182	NA	43	335	NA	53	542	361	68	801	493	80	1118	679	94	1492	910	
	15	NA	NA	NA	40	174	NA	50	321	NA	62	528	353	80	782	482	93	1095	666	109	1465	895	
	20	NA	NA	NA	47	166	NA	59	311	NA	71	513	344	90	763	471	105	1073	653	122	1438	880	
	30	NA	NA	NA	NA	NA	NA	78	290	NA	92	483	NA	115	726	449	131	1029	627	149	1387	849	
	50	NA	NA	NA	NA	NA	NA	NA	NA	NA	147	428	NA	180	651	405	197	944	575	217	1288	787	

**Table 1 - Single Appliance** (continued)

**Capacity of Type B Double-Wall Vents  
when connected directly to a Single Category I Appliance**

Height H (ft.)	Lateral L (ft.)	Vent Diameter - D																							
		10 in.			12 in.			14 in.			16 in.			18 in.			20 in.			22 in.			24 in.		
		Appliance Input Rating in Thousands of Btu per Hour																							
		FAN		NAT		FAN		NAT		FAN		NAT		FAN		NAT		FAN		NAT		FAN		NAT	
Min	Max	Max	Min	Max	Max	Min	Max	Max	Min	Max	Max	Min	Max	Max	Min	Max	Max	Min	Max	Max	Min	Max	Max		
6	0	0	1121	570	0	1645	850	0	2267	1170	0	2983	1530	0	3802	1960	0	4721	2430	0	5737	2950	0	6853	3520
	2	75	675	455	103	982	650	138	1346	890	178	1769	1170	225	2250	1480	296	2782	1850	360	3377	2220	426	4030	2670
	4	110	668	445	147	975	640	191	1338	880	242	1761	1160	300	2242	1475	390	2774	1835	469	3370	2215	555	4023	2660
	6	128	661	435	171	967	630	219	1330	870	276	1753	1150	341	2235	1470	437	2767	1820	523	3363	2210	618	4017	2650
8	0	0	1261	660	0	1858	970	0	2571	1320	0	3399	1740	0	4333	2220	0	5387	2750	0	6555	3360	0	7838	4010
	2	71	770	515	98	1124	745	130	1543	1020	168	2030	1340	212	2584	1700	278	3196	2110	336	3882	2560	401	4634	3050
	5	115	758	503	154	1110	733	199	1528	1010	251	2013	1330	311	2563	1685	398	3180	2090	476	3863	2545	562	4612	3040
	8	137	746	490	180	1097	720	231	1514	1000	289	2000	1320	354	2552	1670	450	3163	2070	537	3850	2530	630	4602	3030
10	0	0	1377	720	0	2036	1060	0	2825	1450	0	3742	1925	0	4782	2450	0	5955	3050	0	7254	3710	0	8682	4450
	2	68	852	560	93	1244	850	124	1713	1130	161	2256	1480	202	2868	1890	264	3556	2340	319	4322	2840	378	5153	3390
	5	112	839	547	149	1229	829	192	1696	1105	243	2238	1461	300	2849	1871	382	3536	2318	458	4301	2818	540	5132	3371
	10	142	817	525	187	1204	795	238	1669	1080	298	2209	1430	364	2818	1840	459	3504	2280	546	4268	2780	641	5099	3340
15	0	0	1596	840	0	2380	1240	0	3323	1720	0	4423	2270	0	5678	2900	0	7099	3620	0	8665	4410	0	10393	5300
	2	63	1019	675	86	1495	985	114	2062	1350	147	2719	1770	186	3467	2260	239	4304	2800	290	5232	3410	346	6251	4080
	5	105	1003	660	140	1476	967	182	2041	1327	229	2696	1748	283	3442	2235	355	4278	2777	426	5204	3385	501	6222	4057
	10	135	977	635	177	1446	936	227	2009	1289	283	2659	1712	346	3402	2193	432	4234	2739	510	5159	3343	599	6175	4019
15	155	953	610	202	1418	905	257	1976	1250	318	2623	1675	385	3363	2150	479	4192	2700	564	5115	3300	665	6129	3980	
20	0	0	1756	930	0	2637	1350	0	3701	1900	0	4948	2520	0	6376	3250	0	7988	4060	0	9785	4980	0	11753	6000
	2	59	1150	755	81	1694	1100	107	2343	1520	139	3097	2000	175	3955	2570	220	4916	3200	269	5983	3910	321	7154	4700
	5	101	1133	738	135	1674	1079	174	2320	1498	219	3071	1978	270	3926	2544	337	4885	3174	403	5950	3880	475	7119	4662
	10	130	1105	710	172	1641	1045	220	2282	1460	273	3029	1940	334	3880	2500	413	4835	3130	489	5896	3830	573	7063	4600
15	150	1078	688	195	1609	1018	248	2245	1425	306	2988	1910	372	3835	2465	459	4786	3090	541	5844	3795	631	7007	4575	
20	167	1052	665	217	1578	990	273	2210	1390	335	2948	1880	404	3791	2430	495	4737	3050	585	5792	3760	689	6953	4550	
30	0	0	1977	1060	0	3004	1550	0	4252	2170	0	5725	2920	0	7420	3770	0	9341	4750	0	11483	5850	0	13484	7060
	2	54	1351	865	74	2004	1310	98	2786	1800	127	3696	2380	159	4734	3050	199	5900	3810	241	7194	4650	285	8617	5600
	5	96	1332	851	127	1981	1289	164	2759	1775	206	3666	2350	252	4701	3020	312	5863	3783	373	7155	4622	439	8574	5552
	10	125	1301	829	164	1944	1254	209	2716	1733	259	3617	2300	316	4647	2970	386	5803	3739	456	7090	4574	535	8505	5471
15	143	1272	807	187	1908	1220	237	2674	1692	292	3570	2250	354	4594	2920	431	5744	3695	507	7026	4527	590	7437	5391	
20	160	1243	784	207	1873	1185	260	2633	1650	319	3523	2200	384	4542	2870	467	5686	3650	548	6964	4480	639	8370	5310	
30	195	1189	745	246	1807	1130	305	2555	1585	369	3433	2130	440	4442	2785	540	5574	3565	635	6842	4375	739	8239	5225	
50	0	0	2231	1195	0	3441	1825	0	4934	2550	0	6711	3440	0	8774	4460	0	11129	5635	0	13767	6940	0	16694	8430
	2	41	1620	1010	66	2431	1513	86	3409	2125	113	4554	2840	141	5864	3670	171	7339	4630	209	8980	5695	251	10788	6860
	5	90	1600	996	118	2406	1495	151	3380	2102	191	4520	2813	234	5826	3639	283	7295	4597	336	8933	5654	394	10737	6818
	10	118	1567	972	154	2366	1466	196	3332	2064	243	4464	2767	295	5763	3585	355	7224	4542	419	8855	5585	491	10652	6749
15	136	1536	948	177	2327	1437	222	3285	2026	274	4409	2721	330	5701	3534	396	7155	4511	465	8779	5546	542	10570	6710	
20	151	1505	924	195	2288	1408	244	3239	1987	300	4356	2675	361	5641	3481	433	7086	4479	506	8704	5506	586	10488	6670	
30	183	1446	876	232	2214	1349	287	3150	1910	347	4253	2631	412	5523	3431	494	6953	4421	577	8557	5444	672	10328	6603	
100	0	0	2491	1310	0	3925	2050	0	5729	2950	0	7914	4050	0	10485	5300	0	13454	6700	0	16817	8600	0	20578	10300
	2	30	1975	1170	44	3027	1820	72	4313	2550	95	5834	3500	120	7591	4600	138	9577	5800	169	11803	7200	204	14264	8800
	5	82	1955	1159	107	3002	1803	136	4282	2531	172	5797	3475	208	7548	4566	245	9528	5769	293	11748	7162	341	14204	8756
	10	108	1923	1142	142	2961	1775	180	4231	2500	223	5737	3434	268	7478	4509	318	9447	5717	374	11658	7100	436	14105	8683
15	126	1892	1124	163	2920	1747	206	4182	2469	252	5678	3392	304	7409	4451	358	9367	5665	418	11569	7037	487	14007	8610	
20	141	1861	1107	181	2880	1719	226	4133	2438	277	5619	3351	330	7341	4394	387	9289	5613	452	11482	6975	523	13910	8537	
30	170	2802	1071	215	2803	1663	265	4037	2375	319	5505	3267	378	7209	4279	446	9136	5509	514	11310	6850	592	13720	8391	
50	241	1688	1000	292	2657	1550	350	3856	2250	415	5289	3100	486	6956	4050	572	8841	5300	659	10979	6600	752	13354	8100	

**Table 2 - Single Appliance**

**Capacity of Type B Double-Wall Vents with Single-Wall Metal Connectors  
(including AmeriVent listed flexible connector) serving a Single Category I Appliance**

Height <i>H</i> (ft.)	Lateral <i>L</i> (ft.)	Vent Diameter - <i>D</i>															
		3 in.			4 in.			5 in.			6 in.			7 in.			
		Appliance Input Rating in Thousands of Btu per Hour															
		FAN		NAT	FAN		NAT	FAN		NAT	FAN		NAT	FAN		NAT	
Min	Max	Max	Min	Max	Max	Min	Max	Max	Min	Max	Max	Min	Max	Max	Min	Max	Max
6	0	38	77	45	59	151	85	85	249	140	126	373	204	165	522	284	
	2	39	51	36	60	96	66	85	156	104	123	231	156	159	320	213	
	4	NA	NA	33	74	92	63	102	152	102	146	225	152	187	313	208	
	6	NA	NA	31	83	89	60	114	147	99	163	220	148	207	307	203	
8	0	37	83	50	58	164	93	83	273	154	123	412	234	161	580	319	
	2	39	56	39	59	108	75	83	176	119	121	261	179	155	363	246	
	5	NA	NA	37	77	102	69	107	168	114	151	252	171	193	352	235	
	8	NA	NA	33	90	95	64	122	161	107	175	243	163	223	342	225	
10	0	37	87	53	57	174	99	82	293	165	120	444	254	158	628	344	
	2	39	61	41	59	117	80	82	193	128	119	286	194	153	400	272	
	5	52	56	39	76	111	76	105	185	122	148	277	186	190	388	261	
	10	NA	NA	34	97	100	68	132	171	112	188	261	171	237	369	241	
15	0	36	93	57	56	190	111	80	325	186	116	499	283	153	713	388	
	2	38	69	47	57	136	93	80	225	149	115	337	334	148	473	314	
	5	51	63	44	75	128	86	102	216	140	144	326	217	182	459	298	
	10	NA	NA	39	95	116	79	128	201	131	182	308	203	228	438	284	
15	NA	NA	NA	NA	NA	72	158	186	124	220	290	192	272	418	269		
20	0	35	96	60	54	200	118	78	346	201	114	537	306	149	772	428	
	2	37	74	50	56	148	99	78	248	165	113	375	248	144	528	344	
	5	50	68	47	73	140	94	100	239	158	141	363	239	178	514	334	
	10	NA	NA	41	93	129	86	125	223	146	177	344	224	222	491	316	
	15	NA	NA	NA	NA	NA	80	155	208	136	216	325	210	265	469	301	
	20	NA	NA	NA	NA	NA	NA	186	192	126	254	306	196	309	448	285	
30	0	34	99	63	53	211	127	76	372	219	110	584	334	144	849	472	
	2	37	80	56	55	164	111	76	281	183	109	429	279	139	610	392	
	5	49	74	52	72	157	106	98	271	173	136	417	271	171	595	382	
	10	NA	NA	NA	91	144	98	122	255	168	171	397	257	213	570	367	
	15	NA	NA	NA	115	131	NA	151	239	157	208	377	242	255	547	359	
	20	NA	NA	NA	NA	NA	NA	181	223	NA	246	356	228	298	524	333	
30	NA	NA	NA	NA	NA	NA	NA	NA	NA	NA	NA	NA	NA	389	477	305	
50	0	33	99	66	51	213	133	73	394	230	105	629	361	138	928	515	
	2	36	84	61	53	181	121	73	318	205	104	495	312	133	712	443	
	5	48	80	NA	70	174	117	94	308	198	131	482	305	164	696	435	
	10	NA	NA	NA	89	160	NA	118	292	186	162	461	292	203	671	420	
	15	NA	NA	NA	112	148	NA	145	275	174	199	441	280	244	646	405	
	20	NA	NA	NA	NA	NA	NA	176	257	NA	236	420	267	285	622	389	
30	NA	NA	NA	NA	NA	NA	NA	NA	NA	315	376	NA	373	573	NA		
100	0	NA	NA	NA	49	214	NA	69	403	NA	100	659	395	131	991	555	
	2	NA	NA	NA	51	192	NA	70	351	NA	98	563	373	125	828	508	
	5	NA	NA	NA	67	186	NA	90	342	NA	125	551	366	156	813	501	
	10	NA	NA	NA	85	175	NA	113	324	NA	153	532	354	191	789	486	
	15	NA	NA	NA	132	162	NA	138	310	NA	188	511	343	230	764	473	
	20	NA	NA	NA	NA	NA	NA	168	295	NA	224	487	NA	270	739	458	
	30	NA	NA	NA	NA	NA	NA	231	264	NA	301	448	NA	355	685	NA	
50	NA	NA	NA	NA	NA	NA	NA	NA	NA	NA	NA	NA	NA	540	584	NA	

**Table 2 - Single Appliance** (continued)

**Capacity of Type B Double-Wall Vents with Single-Wall Metal Connectors  
 (including AmeriVent listed flexible connector) serving a Single Category I Appliance**

Height <i>H</i> (ft.)	Lateral <i>L</i> (ft.)	Vent Diameter - <i>D</i>											
		8 in.			9 in.			10 in.			12 in.		
		Appliance Input Rating in Thousands of Btu per Hour											
		FAN		NAT	FAN		NAT	FAN		NAT	FAN		NAT
Min	Max	Max	Min	Max	Max	Min	Max	Max	Min	Max	Max		
6	0	211	695	369	267	894	469	371	1118	569	537	1639	849
	2	201	423	284	251	541	368	347	673	453	498	979	648
	4	237	416	277	295	533	360	409	664	443	584	971	638
	6	263	409	271	327	526	352	449	656	433	638	962	627
8	0	206	777	414	258	1002	536	360	1257	658	521	1852	967
	2	197	482	321	246	617	417	339	768	513	486	1120	743
	5	245	470	311	305	604	404	418	754	500	598	1104	730
	8	280	458	300	344	591	392	470	740	486	665	1089	715
10	0	202	844	449	253	1093	584	351	1373	718	507	2031	1057
	2	193	531	354	242	681	456	332	849	559	475	1242	848
	5	241	518	344	299	667	443	409	834	544	584	1224	825
	10	296	497	325	363	643	423	492	808	520	688	1194	788
15	0	195	966	523	244	1259	681	336	1591	838	488	2374	1237
	2	187	631	413	232	812	543	319	1015	673	457	1491	983
	5	231	616	400	287	795	526	392	997	657	562	1469	963
	10	284	592	381	349	768	501	470	966	628	664	1433	928
	15	334	568	367	404	742	484	540	937	601	750	1399	894
20	0	190	1053	573	238	1379	750	326	1751	927	473	2631	1346
	2	182	708	468	227	914	611	309	1146	754	443	1689	1098
	5	224	692	457	279	896	596	381	1126	734	547	1665	1074
	10	277	666	437	339	866	570	457	1092	702	646	1626	1037
	15	325	640	419	393	838	549	526	1060	677	730	1587	1005
	20	374	616	400	448	810	526	592	1028	651	808	1550	973
30	0	184	1168	647	229	1542	852	312	1971	1056	454	2996	1545
	2	175	823	533	219	1069	698	296	1346	863	424	1999	1308
	5	215	806	521	269	1049	864	366	1324	846	524	1971	1283
	10	265	777	501	327	1017	662	440	1287	821	620	1927	1243
	15	312	750	481	379	985	638	507	1251	794	702	1884	1205
	20	360	723	461	433	955	615	570	1216	768	780	1841	1166
	30	461	670	426	541	895	574	704	1147	720	937	1759	1101
50	0	176	1292	704	220	1724	948	295	2223	1189	428	3432	1818
	2	168	971	613	209	1273	811	280	1615	1007	401	2426	1509
	5	204	953	602	257	1252	795	347	1591	991	496	2396	1490
	10	253	923	583	313	1217	765	418	1551	963	589	2347	1455
	15	299	894	562	363	1183	736	481	1512	934	668	2299	1421
	20	345	866	543	415	1150	708	544	1473	906	741	2251	1387
	30	442	809	502	521	1086	649	674	1399	848	892	2159	1318
100	0	166	1404	765	207	1900	1033	273	2479	1300	395	3912	2042
	2	158	1152	698	196	1532	933	259	1970	1168	371	3021	1817
	5	194	1134	688	240	1511	921	322	1945	1153	460	2990	1796
	10	238	1104	672	293	1477	902	389	1905	1133	547	2938	1763
	15	281	1075	656	342	1443	884	447	1865	1110	618	2888	1730
	20	325	1046	639	391	1410	864	507	1825	1087	690	2838	1696
	30	418	988	NA	491	1343	824	631	1747	1041	834	2739	1627
50	617	866	NA	711	1205	NA	895	1591	NA	1138	2547	1489	

## Examples using Single-Appliance Venting Tables

### Example 1: Single Draft Hood-Equipped Appliance

An installer has a 120,000-Btu/hour input appliance with a 5-inch diameter draft hood outlet that needs to be vented into a 10-foot high Type B vent system. What size vent should be used, assuming (1) a 5-foot lateral single-wall metal vent connector is used with two 90-degree elbows, or (2) a 5-foot lateral single-wall metal vent connector is used with three 90-degree elbows in the vent system? See **Figure 3**.

#### Solution

**Table 2** should be used to solve this problem, because single-wall metal vent connectors are being used with a Type B vent.

- Read down the first column in **Table 2** until the row associated with a 10-foot height and 5-foot lateral is found. Read across this row until a vent capacity greater than 120,000 Btu/hour is located in the shaded columns labeled NAT Max for draft hood-equipped appliances. In this case, a 5-inch diameter vent has a capacity of 122,000 Btu/hour and can be used for this application.
- If three 90-degree elbows are used in the vent system, then the maximum vent capacity listed in the tables must be reduced by 10 percent (see **Paragraph 3**). This implies that the 5-inch diameter vent has an adjusted capacity of only 110,000 Btu/hour. In this case, the vent system must be increased to 6 inches in diameter. See the following calculations.

$$122,000 \times 0.90 = 110,000 \text{ for 5-inch vent}$$

From **Table 2**, select 6-inch vent.

$$186,000 \times 0.90 = 167,000; \text{ This figure is greater than the required 120,000.}$$

Therefore, use a 6-inch vent and connector where three elbows are used.

### Example 2: Single Fan-Assisted Appliance

An installer has an 80,000-Btu/hour input fan-assisted appliance that must be installed using 10 feet of lateral connector attached to a 30-foot high Type B vent. Two 90-degree elbows are needed for the installation. Can a single-wall metal vent connector be used for this application? See **Figure 4**.

#### Solution

**Table 2** refers to the use of single-wall metal vent connectors with Type B vent. In the first column, find the row associated with a 30-foot height and a 10-foot lateral. Read across this row, looking at the FAN Min and FAN Max columns, to find that a 3-inch diameter single-wall metal vent connector is not recommended. Moving to the next larger size single-wall connector (4 inches), we find that a 4-inch diameter single-wall metal connector has a recommended minimum vent capacity of 91,000 Btu/hour and a recommended maximum vent capacity of 144,000 Btu/hour. The 80,000 Btu/hour fan-assisted appliance is outside this range, so the conclusion is that a single-wall metal vent connector cannot be used to vent this appliance using 10 feet of lateral for the connector. However, if the 80,000 Btu/hour input appliance could be moved to within 5 feet of the vertical vent, then a 4-inch single-wall metal connector could be used to vent the appliance. **Table 2** shows the acceptable range of vent capacities for a 4-inch vent with 5 feet of lateral to be between 72,000 Btu/hour and 157,000 Btu/hour. If the appliance cannot be moved closer to the vertical vent, then Type B vent could be used as the connector material. In this case, **Table 1** shows that, for a 30-foot high vent with 10 feet of lateral, the acceptable range of vent capacities for a 4-inch diameter vent attached to a fan-assisted appliance is between 37,000 Btu/hour and 150,000 Btu/hour.

**Examples using Single-Appliance Venting Tables** (continued)

**Example 3: Interpolating Between Table Values**

An installer has an 80,000-Btu/hour input appliance with a 4-inch diameter draft hood outlet that needs to be vented into a 12-foot high Type B vent. The vent connector has a 5-foot lateral length and is also Type B. Can this appliance be vented using a 4-inch diameter vent?

**Solution**

**Table 1** is used in the case of an all Type B vent system. However, since there is no entry in **Table 1** for a height of 12 feet, interpolation must be used. Read down the 4-inch diameter NAT Max column to the row associated with 10-foot height and 5-foot lateral to find the capacity value of 77,000 Btu/hour. Read further down to the 15-foot height, 5-foot lateral row to find the capacity value of 87,000 Btu/hour. The difference between the 15-foot height capacity value and the 10-foot height capacity value is 10,000 Btu/hour. The capacity for a vent system with a 12-foot height is equal to the capacity for a 10-foot height plus 2/5 of the difference between the 10-foot and 15-foot height values, or  $77,000 + \frac{2}{5} \times 10,000 = 81,000$  Btu/hour. Therefore, a 4-inch diameter vent can be used in the installation.

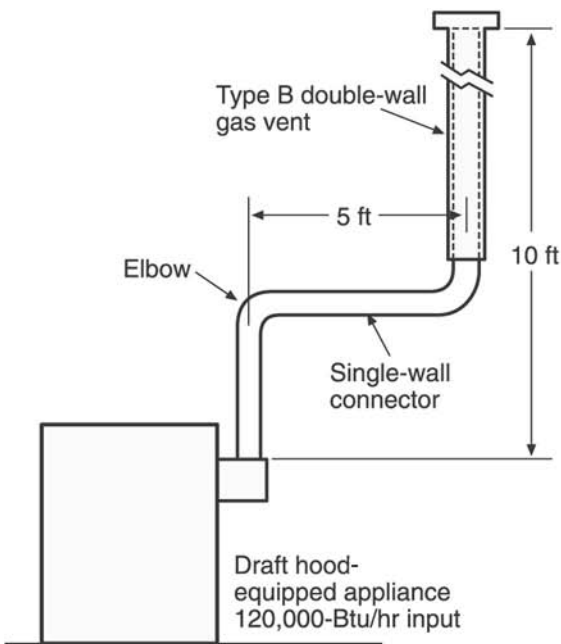

**Figure 3**

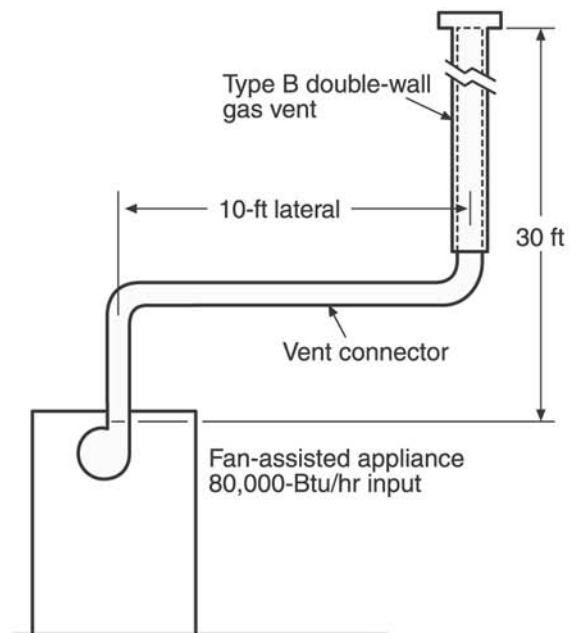

**Figure 4**

## Two or More Appliances - Tables 3 and 4

### Notes for Multiple-Appliance Vent

1. These venting tables shall not be used where heat reclaimers, draft regulators and vent dampers are installed in the venting system.
2. The maximum vent connector horizontal length shall be 18 inches/inch (180 mm/mm) of connector diameter as follows.

Connector Diameter Maximum (inches)	Connector Horizontal Length (feet)
3	4½
4	6
5	7½
6	9
7	10½
8	12
9	13½
10	15
12	18
14	21
16	24
18	27
20	30
22	33
24	36

3. The vent connector shall be routed to the vent utilizing the shortest possible route. Connectors with longer horizontal lengths than those listed above are permitted under the following conditions.
  - a) The maximum capacity (FAN Max or NAT Max) of the vent connector shall be reduced 10 percent for each additional multiple of the length listed above. For example, the maximum length listed for a 4-inch (100 mm) connector is 6 feet (1.8 m). With a connector length greater than 6 feet (1.8 m) but not exceeding 12 feet (3.7 m), the maximum capacity must be reduced by 10 percent (0.90 x maximum vent connector capacity). With a connector length greater than 12 feet (3.7 m) but not exceeding 18 feet (5.5 m), the maximum capacity must be reduced by 20 percent (0.80 x maximum vent capacity).
  - b) For a connector serving a fan-assisted appliance, the minimum capacity (FAN Min) of the connector shall be determined by referring to the corresponding single-appliance table. For Type B double-wall connectors, **Table 1** shall be used. For single-wall connectors, **Table 2** shall be used. The height (H) and lateral (L) shall be measured according to the procedures for a single-appliance vent, as if the other appliances were not present.

**Two or More Appliances - Tables 3 and 4** (continued)

4. If the vent connectors are combined prior to entering the common vent, the maximum common vent capacity listed in the common venting tables shall be reduced by 10 percent (0.90 x maximum common vent capacity). The length of the common vent connector manifold (LM) shall not exceed 18 inches/inch (180 mm/mm) of common vent connector manifold diameter (D). (See **Figure 7**.)
5. If the common vertical vent is offset as shown in **Figure 8**, the maximum common vent capacity listed in the common venting tables shall be reduced by 20 percent (0.80 x maximum common vent capacity), the equivalent of two 90-degree turns. The horizontal length of the common vent offset (LM) shall not exceed 18 inches/inch (180 mm/mm) of common vent diameter (D).
6. Excluding elbows counted in Paragraph 5, for each additional 90-degree turn in excess of two, the maximum capacity of that portion of the venting system shall be reduced by 10 percent (0.90 x maximum common vent capacity). Two or more turns, the combined angles of which equal 90 degrees, shall be considered equivalent to one 90-degree turn. (See NFPA 54 for more information.)
7. The cross-sectional area of the common vent shall be equal to or greater than the cross-sectional area of the largest connector.
8. Interconnection fittings shall be the same size as the common vent.
9. Sea-level input ratings shall be used when determining maximum capacity for high-altitude installation. Actual input (derated for altitude) shall be used for determining minimum capacity for high-altitude installation.

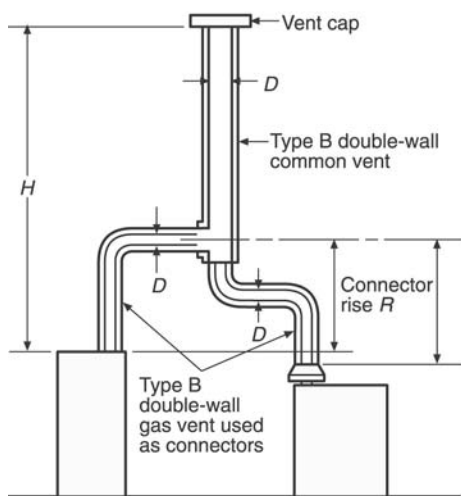

**Figure 5**

**Table 3** is used when sizing Type B double-wall vent connectors attached to a Type B double-wall common vent.

**Note:** Each appliance type may be either Category I draft hood-equipped or fan-assisted.

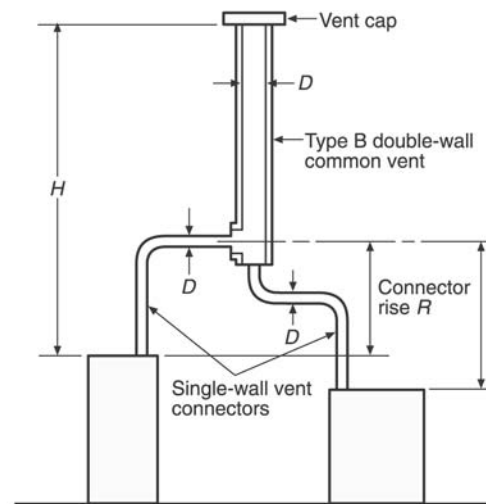

**Figure 6**

**Table 4** is used when sizing single-wall vent connectors attached to a Type B double-wall common vent.

**Note:** Each appliance type may be either Category I draft hood-equipped or fan-assisted.

## Two or More Appliances - Tables 3 and 4 (continued)

10. The connector rise (R) for each appliance connector shall be measured from the draft hood outlet or flue collar to the centerline where the vent gas streams come together.
11. For multiple units of gas utilization equipment all located on one floor, available total height (H) shall be measured from the highest draft hood outlet or flue collar up to the level of the outlet of the common vent.
 

**NOTE:** For multistory installations, refer to the National Fuel Gas Code.
12. Where two or more appliances are connected to a vertical vent or chimney, the flow area of the largest section of vertical vent or chimney shall not exceed seven times the smallest listed appliance categorized vent areas, flue collar area, or draft hood outlet area, unless designed in accordance with approved engineering methods.
13. For appliances with more than one input rate, the minimum vent connector capacity (FAN Min) determined from the tables shall be less than the lowest appliance input rating, and the maximum vent connector capacity (FAN Max or NAT Max) determined from the tables shall be greater than the highest appliance input rating.
14. Listed, corrugated metallic chimney liner systems in masonry chimneys shall be sized by using **Tables 3 and 4** for Type B vents, with the maximum capacity reduced by 20 percent (0.80 x maximum capacity) and the minimum capacity as shown in these tables. Corrugated metallic liner systems installed with bends or offsets shall have their maximum capacity further reduced in accordance with **Paragraph 6** (see NFPA 54 for more information).

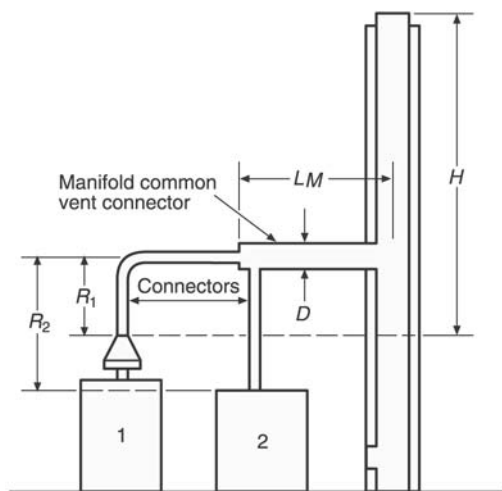

Figure 7

**Example:** Manifolded Common Vent Connector  $L_M$  shall be no greater than  $1\frac{1}{2}$  feet for each inch of manifold diameter; i.e., a 4-inch inside diameter common vent connector manifold shall not exceed 6 feet in length.

**Note:** This is an illustration of a typical manifolded vent connector. Different appliance, vent connector, or common vent types are possible. Consult the notes for common venting.

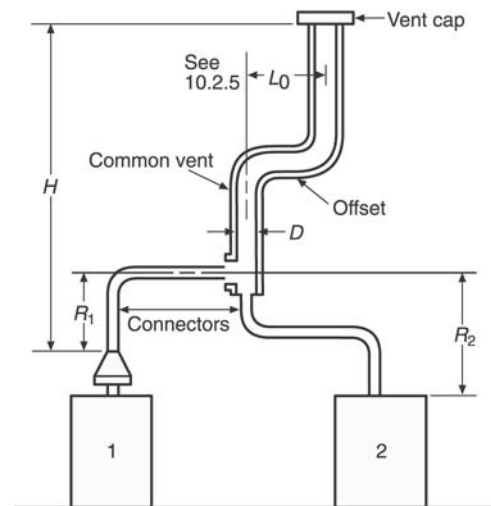

Figure 8

**Example:** Offset Common Vent

**Note:** This is an illustration of a typical offset vent. Different appliance, vent connector, or vent types are possible. Consult the notes for a single appliance and common venting.

## Two or More Appliances - Tables 3 and 4 (continued)

15. **Tables 3 and 4** shall be used for chimneys and vents not exposed to the outdoors below the roof line. A Type B vent or listed chimney lining system passing through an unused masonry chimney flue shall not be considered to be exposed to the outdoors.
16. Vent connectors shall not be upsized more than two sizes greater than the listed appliance categorized vent diameter, flue collar diameter, or draft hood outlet diameter. Vent connectors for draft hood–equipped appliances shall not be smaller than the draft hood outlet diameter. If a vent connector size(s) determined from the tables for a fan-assisted appliance(s) is smaller than the flue collar diameter, the smaller size(s) shall be permitted to be used provided the following conditions are met.
  - a) Vent connectors for fan-assisted appliance flue collars 12 inches (300 mm) in diameter or smaller are not reduced by more than one table size [e.g., 12 inches to 10 inches (300 mm to 250 mm)] is a one-size reduction), and those larger than 12 inches (300 mm) in diameter are not reduced more than two table sizes [e.g., 24 inches to 20 inches (610 mm to 510 mm) is a two-size reduction].
  - b) The fan-assisted appliance(s) is common vented with a draft hood–equipped appliance(s).
17. All combination of pipe sizes, single-wall, and double-wall metal pipe shall be allowed within any connector run(s) or within the common vent, provided ALL of the appropriate tables permit ALL of the desired sizes and types of pipe, as if they were used for the entire length of the subject connector or vent. If single-wall and Type B double-wall metal pipes are used for vent connectors, the common vent must be sized using **Table 4** as appropriate. (See NFPA 54 for more information.)
18. Where a table permits more than one diameter of pipe to be used for a connector or vent, all the permitted sizes shall be permitted to be used.
19. Interpolation shall be permitted in calculating capacities for vent dimensions that fall between table entries. (See Example 3.)
20. Extrapolation beyond the table entries shall not be permitted.
21. For vent heights lower than 6 feet and higher than shown in the tables, engineering methods shall be used to calculate vent capacities. For SI units, 1 inch = 25.4 mm; 1 inch<sup>2</sup> = 645 mm<sup>2</sup>; 1 foot, = 0.305 m; 1000 Btu per hour = 0.293 kW.

### Table 3 - Two or More Appliances

Capacity of Type B Double-Wall Vents with Type B Double-Wall Connectors serving Two or More Category I Appliances

Vent Connector Capacity

Vent Height H (ft.)	Connector Rise R (ft.)	Type B Double-Wall Vent and Connector Diameter - D																							
		3 in.			4 in.			5 in.			6 in.			7 in.			8 in.			9 in.			10 in.		
		Appliance Input Rating Limits in Thousands of Btu per Hour																							
		FAN		NAT	FAN		NAT	FAN		NAT	FAN		NAT	FAN		NAT	FAN		NAT	FAN		NAT	FAN		NAT
Min	Max	Max	Min	Max	Max	Min	Max	Max	Min	Max	Max	Min	Max	Max	Min	Max	Max	Min	Max	Max	Min	Max	Max		
6	1	22	37	26	35	66	46	46	106	72	58	164	104	77	225	142	92	296	185	109	376	237	128	466	289
	2	23	41	31	37	75	55	48	121	86	60	183	124	79	253	168	95	333	220	112	424	282	131	526	345
	3	24	44	35	38	81	62	49	132	96	62	199	139	82	275	189	97	363	248	114	463	317	134	575	386
8	1	22	40	27	35	72	48	49	114	76	64	176	109	84	243	148	100	320	194	118	408	248	138	507	303
	2	23	44	32	36	80	57	51	128	90	66	195	129	86	269	175	103	356	230	121	454	294	141	564	358
	3	24	47	36	37	87	64	53	139	101	67	210	145	88	290	198	105	384	258	123	492	330	143	612	402
10	1	22	43	28	34	78	50	49	123	78	65	189	113	89	257	154	106	341	200	125	436	257	146	542	314
	2	23	47	33	36	86	59	51	136	93	67	206	134	91	282	182	109	374	238	128	479	305	149	596	372
	3	24	50	37	37	92	67	52	146	104	69	220	150	94	303	205	111	402	268	131	515	342	152	642	417
15	1	21	50	30	33	89	53	47	142	83	64	220	120	88	298	163	110	389	214	134	493	273	162	609	333
	2	22	53	35	35	96	63	49	153	99	66	235	142	91	320	193	112	419	253	137	532	323	165	658	394
	3	24	55	40	36	102	71	51	163	111	68	248	160	93	339	218	115	445	286	140	565	365	167	700	444
20	1	21	54	31	33	99	56	46	157	87	62	246	125	86	334	171	107	436	224	131	552	285	158	681	347
	2	22	57	37	34	105	66	48	167	104	64	259	149	89	354	202	110	463	265	134	587	339	161	725	414
	3	23	60	42	35	110	74	50	176	116	66	271	168	91	371	228	113	486	300	137	618	383	164	764	466
30	1	20	62	33	31	113	59	45	181	93	60	288	134	83	391	182	103	512	238	125	649	305	151	802	372
	2	21	64	39	33	118	70	47	190	110	62	299	158	85	408	215	105	535	282	129	679	360	155	840	439
	3	22	66	44	34	123	79	48	198	124	64	309	178	88	423	242	108	555	317	132	706	405	158	874	494
50	1	19	71	36	30	133	64	43	216	101	57	349	145	78	477	197	97	627	257	120	797	330	144	984	403
	2	21	73	43	32	137	76	45	223	119	59	358	172	81	490	234	100	645	306	123	820	392	148	1014	478
	3	22	75	48	33	141	86	46	229	134	61	366	194	83	502	263	103	661	343	126	842	441	151	1043	538
100	1	18	82	37	28	158	66	40	262	104	53	442	150	73	611	204	91	810	266	112	1038	341	135	1285	417
	2	19	83	44	30	161	79	42	267	123	55	447	178	75	619	242	94	822	316	115	1054	405	139	1306	494
	3	20	84	50	31	163	89	44	272	138	57	452	200	78	627	272	97	834	355	118	1069	455	142	1327	555

Common Vent Capacity

Vent Height H (ft.)	Type B Double-Wall Vent Diameter - D																							
	4 in.			5 in.			6 in.			7 in.			8 in.			9 in.			10 in.					
	Combined Appliance Input Rating in Thousands of Btu per Hour																							
	FAN		FAN	NAT	FAN		FAN	NAT	FAN		FAN	NAT	FAN		FAN	NAT	FAN		FAN	NAT	FAN		FAN	NAT
+FAN	+NAT	+NAT	+FAN	+NAT	+NAT	+FAN	+NAT	+NAT	+FAN	+NAT	+NAT	+FAN	+NAT	+NAT	+FAN	+NAT	+NAT	+FAN	+NAT	+NAT	+FAN	+NAT	+NAT	
6	92	81	65	140	116	103	204	161	147	309	248	200	404	314	260	547	434	335	672	520	410			
8	101	90	73	155	129	114	224	178	163	339	275	223	444	348	290	602	480	378	740	577	465			
10	110	97	79	169	141	124	243	194	178	367	299	242	477	377	315	649	522	405	800	627	495			
15	125	112	91	195	164	144	283	228	206	427	352	280	556	444	365	753	612	465	924	733	565			
20	136	123	102	215	183	160	314	255	229	475	394	310	621	499	405	842	688	523	1035	826	640			
30	152	138	118	244	210	185	361	297	266	547	459	360	720	585	470	979	808	605	1209	975	740			
50	167	153	134	279	244	214	421	353	310	641	547	423	854	706	550	1164	977	705	1451	1188	860			
100	175	163	NA	311	277	NA	489	421	NA	751	658	479	1025	873	625	1408	1215	800	1784	1502	975			

### Table 3 - Two or More Appliances (continued)

#### Capacity of Type B Double-Wall Vents with Type B Double-Wall Connectors serving Two or More Category I Appliances

##### Vent Connector Capacity

Vent Height <i>H</i> (ft.)	Connector Rise <i>R</i> (ft.)	Type B Double-Wall Vent and Connector Diameter - <i>D</i>																					
		12 in.			14 in.			16 in.			18 in.			20 in.			22 in.			24 in.			
		Appliance Input Rating Limits in Thousands of Btu per Hour																					
		FAN			NAT			FAN			NAT			FAN			NAT			FAN			NAT
Min		Max	Min		Max	Min		Max	Min		Max	Min		Max	Min		Max	Min		Max	Min		Max
6	2	174	764	496	223	1046	653	281	1371	853	346	1772	1080	NA	NA	NA	NA	NA	NA	NA	NA	NA	
	4	180	897	616	230	1231	827	287	1617	1081	352	2069	1370	NA	NA	NA	NA	NA	NA	NA	NA	NA	
	6	NA	NA	NA	NA	NA	NA	NA	NA	NA	NA	NA	NA	NA	NA	NA	NA	NA	NA	NA	NA	NA	
8	2	186	822	516	238	1126	696	298	1478	910	365	1920	1150	NA	NA	NA	NA	NA	NA	NA	NA	NA	
	4	192	952	644	244	1307	884	305	1719	1150	372	2211	1460	471	2737	1800	560	3319	2180	662	3957	2590	
	6	198	1050	772	252	1445	1072	313	1902	1390	380	2434	1770	478	3018	2180	568	3665	2640	669	4373	3130	
10	2	196	870	536	249	1195	730	311	1570	955	379	2049	1205	NA	NA	NA	NA	NA	NA	NA	NA	NA	
	4	201	997	664	256	1371	924	318	1804	1205	387	2332	1535	486	2887	1890	581	3502	2280	686	4175	2710	
	6	207	1095	792	263	1509	1118	325	1989	1455	395	2556	1865	494	3169	2290	589	3849	2760	694	4593	3270	
15	2	214	967	568	272	1334	790	336	1760	1030	408	2317	1305	NA	NA	NA	NA	NA	NA	NA	NA	NA	
	4	221	1085	712	279	1499	1006	344	1978	1320	416	2579	1665	523	3197	2060	624	3881	2490	734	4631	2960	
	6	228	1181	856	286	1632	1222	351	2157	1610	424	2796	2025	533	3470	2510	634	4216	3030	743	5035	3600	
20	2	223	1051	596	291	1443	840	357	1911	1095	430	2533	1385	NA	NA	NA	NA	NA	NA	NA	NA	NA	
	4	230	1162	748	298	1597	1064	365	2116	1395	438	2778	1765	554	3447	2180	661	4190	2630	772	5005	3130	
	6	237	1253	900	307	1726	1288	373	2287	1695	450	2984	2145	567	3708	2650	671	4511	3190	785	5392	3790	
30	2	216	1217	632	286	1664	910	367	2183	1190	461	2891	1540	NA	NA	NA	NA	NA	NA	NA	NA	NA	
	4	223	1316	792	294	1802	1160	376	2366	1510	474	3110	1920	619	3840	2365	728	4861	2860	847	5606	3410	
	6	231	1400	952	303	1920	1410	384	2524	1830	485	3299	2340	632	4080	2875	741	4976	3480	860	5961	4150	
50	2	206	1479	689	273	2023	1007	350	2659	1315	435	3548	1665	NA	NA	NA	NA	NA	NA	NA	NA	NA	
	4	213	1561	860	281	2139	1291	359	2814	1685	447	3730	2135	580	4601	2633	709	5569	3185	851	6633	3790	
	6	221	1631	1031	290	2242	1575	369	2951	2055	461	3893	2605	594	4808	3208	724	5826	3885	867	6943	4620	
100	2	192	1923	712	254	2644	1050	326	3490	1370	402	4707	1740	NA	NA	NA	NA	NA	NA	NA	NA	NA	
	4	200	1984	888	263	2731	1346	336	3606	1760	414	4842	2220	523	5982	2750	639	7254	3330	769	8650	3950	
	6	208	2035	1064	272	2811	1642	346	3714	2150	426	4968	2700	539	6143	3350	654	7453	4070	786	8892	4810	

##### Common Vent Capacity

Vent Height <i>H</i> (ft.)	Type B Double-Wall Vent Diameter - <i>D</i>																						
	12 in.			14 in.			16 in.			18 in.			20 in.			22 in.			24 in.				
	Combined Appliance Input Rating in Thousands of Btu per Hour																						
	FAN			FAN			FAN			FAN			FAN			FAN			FAN				
+FAN		+NAT	+NAT	+FAN		+NAT	+NAT	+FAN		+NAT	+NAT	+FAN		+NAT	+NAT	+FAN		+NAT	+NAT	+FAN		+NAT	+NAT
6	900	696	588	1284	990	815	1735	1336	1065	2253	1732	1345	2838	2180	1660	3488	2677	1970	4206	3226	2390		
8	994	773	652	1423	1103	912	1927	1491	1190	2507	1936	1510	3162	2439	1860	3890	2998	2200	4695	3616	2680		
10	1076	841	712	1542	1200	995	2093	1625	1300	2727	2113	1645	3444	2665	2030	4241	3278	2400	5123	3957	2920		
15	1247	986	825	1794	1410	1158	2440	1910	1510	3184	2484	1910	4026	3133	2360	4971	3862	2790	6016	4670	3400		
20	1405	1116	916	2006	1588	1290	2722	2147	1690	3561	2798	2140	4548	3552	2640	5573	4352	3120	6749	5261	3800		
30	1658	1327	1025	2373	1892	1525	3220	2558	1990	4197	3326	2520	5303	4193	3110	6539	5157	3680	7940	6247	4480		
50	2024	1640	1280	2911	2347	1863	3964	3183	2430	5184	4149	3075	6567	5240	3800	8116	6458	4500	9837	7813	5475		
100	2569	2131	1670	3732	3076	2450	5125	4202	3200	6749	5509	4050	8597	6986	5000	10681	8648	5920	13004	10499	7200		

**Table 4 - Two or More Appliances**

**Capacity of Type B Double-Wall Vents with Single-Wall Metal Connectors  
(including AmeriVent listed flexible connector) serving Two or More Category I Appliances**

**Vent Connector Capacity**

Vent Height H (ft.)	Connector Rise R (ft.)	Single-Wall Metal Vent Connector Diameter - D																														
		3 in.			4 in.			5 in.			6 in.			7 in.			8 in.			9 in.			10 in.									
		Appliance Input Rating Limits in Thousands of Btu per Hour																														
		FAN			NAT			FAN			NAT			FAN			NAT			FAN			NAT			FAN			NAT			
Min	Max	Max	Min	Max	Max	Min	Max	Max	Min	Max	Max	Min	Max	Max	Min	Max	Max	Min	Max	Max	Min	Max	Max	Min	Max	Max	Min	Max	Max	Min	Max	Max
6	1	NA	NA	26	NA	NA	46	NA	NA	71	NA	NA	102	207	223	140	262	293	183	325	373	234	447	463	286							
	2	NA	NA	31	NA	NA	55	NA	NA	85	168	182	123	215	251	167	271	331	219	334	422	281	458	524	344							
	3	NA	NA	34	NA	NA	62	121	131	95	175	198	138	222	273	188	279	361	247	344	462	316	468	574	385							
8	1	NA	NA	27	NA	NA	48	NA	NA	75	NA	NA	106	226	240	145	285	316	191	352	403	244	481	502	299							
	2	NA	NA	32	NA	NA	57	125	126	89	184	193	127	234	266	173	293	353	228	360	450	292	492	560	355							
	3	NA	NA	35	NA	NA	64	130	138	100	191	208	144	241	287	197	302	381	256	370	489	328	501	609	400							
10	1	NA	NA	28	NA	NA	50	119	121	77	182	186	110	240	253	150	302	335	196	372	429	252	506	534	308							
	2	NA	NA	33	84	85	59	124	134	91	189	203	132	248	278	183	311	369	235	381	473	302	517	589	368							
	3	NA	NA	36	89	91	67	129	144	102	197	217	148	257	299	203	320	398	265	391	511	339	528	637	413							
15	1	NA	NA	29	79	87	52	116	138	81	177	214	116	238	291	158	312	380	208	397	482	266	556	596	324							
	2	NA	NA	34	83	94	62	121	150	97	185	230	138	246	314	189	321	411	248	407	522	317	568	646	387							
	3	NA	NA	39	87	100	70	127	160	109	193	243	157	255	333	215	331	438	281	418	557	360	579	690	437							
20	1	49	56	30	78	97	54	115	152	84	175	238	120	233	325	165	306	425	217	390	538	276	546	664	336							
	2	52	59	36	82	103	64	120	163	101	182	252	144	243	346	197	317	453	259	400	574	331	558	709	403							
	3	55	62	40	87	107	72	125	172	113	190	264	164	252	363	223	326	476	294	412	607	375	570	750	457							
30	1	47	60	31	77	110	57	112	175	89	169	278	129	226	380	175	296	497	230	378	630	294	528	779	358							
	2	51	62	37	81	115	67	117	185	106	177	290	152	236	397	208	307	521	274	389	662	349	541	819	425							
	3	54	64	42	85	119	76	122	193	120	185	300	172	244	412	235	316	542	309	400	690	394	555	855	482							
50	1	46	69	34	75	128	60	109	207	96	162	336	137	217	460	188	284	604	245	364	768	314	507	951	384							
	2	49	71	40	79	132	72	114	215	113	170	345	164	226	473	223	294	623	293	376	793	375	520	983	458							
	3	52	72	45	83	136	82	119	221	123	178	353	186	235	486	252	304	640	331	387	816	423	535	1013	518							
100	1	45	79	34	71	150	61	104	249	98	153	424	140	205	585	192	269	774	249	345	993	321	476	1236	393							
	2	48	80	41	75	153	73	110	255	115	160	428	167	212	593	228	279	778	299	358	1011	383	490	1259	469							
	3	51	81	46	79	157	85	114	260	129	168	433	190	222	603	256	289	801	339	368	1027	431	506	1280	527							

**Common Vent Capacity**

Vent Height H (ft.)	Type B Double-Wall Vent Diameter - D																				
	4 in.			5 in.			6 in.			7 in.			8 in.			9 in.			10 in.		
	Combined Appliance Input Rating in Thousands of Btu per Hour																				
	FAN			FAN			FAN			FAN			FAN			FAN			FAN		
+FAN	+FAN	+FAN	+FAN	+FAN	+FAN	+FAN	+FAN	+FAN	+FAN	+FAN	+FAN	+FAN	+FAN	+FAN	+FAN	+FAN	+FAN	+FAN	+FAN	+FAN	
6	NA	78	64	NA	113	99	200	158	144	304	244	196	398	310	257	541	429	332	665	515	407
8	NA	87	71	NA	126	111	218	173	159	331	269	218	436	342	285	592	473	373	730	569	460
10	NA	94	76	163	137	120	237	189	174	357	292	236	467	369	309	638	512	398	787	617	487
15	121	108	88	189	159	140	275	221	200	416	343	274	544	434	357	738	599	456	905	718	553
20	131	118	98	208	177	156	305	247	223	463	383	302	606	487	395	824	673	512	1013	808	626
30	145	132	113	236	202	180	350	286	257	533	446	349	703	570	459	958	790	593	1183	952	723
50	159	145	128	268	233	208	406	337	296	622	529	410	833	686	535	1139	954	689	1418	1157	838
100	166	153	NA	297	263	NA	469	398	NA	726	633	464	999	846	606	1378	1185	780	1741	1459	948

## Examples Using Common Venting Tables

### Example 4: Common-Venting Two Draft Hood-Equipped Appliances

A 35,000-Btu/hour water heater is to be common-vented with a 150,000-Btu/hour furnace, using a common vent with a total height of 30 feet. The connector rise is 2 feet for the water heater, with a horizontal length of 4 feet. The connector rise for the furnace is 3 feet, with a horizontal length of 8 feet. Assuming single-wall metal connectors will be used with Type B vent, what size connectors and combined vent should be used in this installation? See **Figure 9**.

#### Solution

**Table 4** should be used to size single-wall metal vent connectors attached to Type B vertical vents. In the vent connector capacity portion of **Table 4**, find the row associated with a 30-foot vent height. For a 2-foot rise on the vent connector for the water heater, read the shaded columns for draft hood-equipped appliances to find that a 3-inch diameter vent connector has a capacity of 37,000 Btu/hour. Therefore, a 3-inch single-wall metal vent connector can be used with the water heater. For a draft hood-equipped furnace with a 3-foot rise, read across the appropriate row to find that a 5-inch diameter vent connector has a maximum capacity of 120,000 Btu/hour (which is too small for the furnace), and a 6-inch diameter vent connector has a maximum vent capacity of 172,000 Btu/hour. Therefore, a 6-inch diameter vent connector should be used with the 150,000 Btu/hour furnace. Since both vent connector horizontal lengths are less than the maximum lengths listed in **Paragraph 2, Page 12**, the table values can be used without adjustments.

In the common vent capacity portion of **Table 4**, find the row associated with a 30-foot vent height, and read over to the NAT +NAT portion of the 6-inch diameter column to find a maximum combined capacity of 257,000 Btu/hour. Since the two appliances total only 185,000 Btu/hour, a 6-inch common vent can be used.

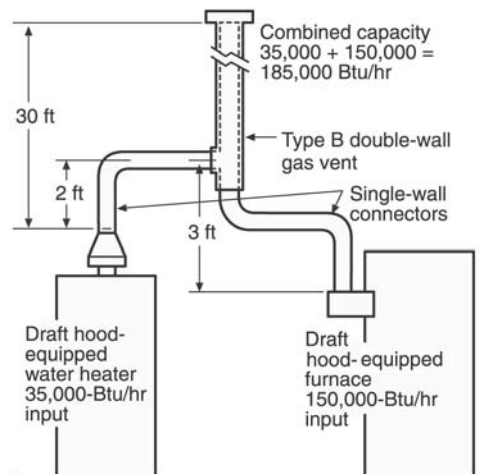

**Figure 9**

## Examples Using Common Venting Tables (continued)

### Example 5: Common-Venting a Draft Hood-Equipped Water Heater with a Fan-Assisted Furnace into a Type B Vent

In this case, a 35,000-Btu/hour input draft hood-equipped water heater with a 4-inch diameter draft hood outlet, 2 feet of connector rise, and 4 feet of horizontal length are to be common-vented with a 100,000 Btu/hour fan-assisted furnace with a 4-inch diameter flue collar, 3 feet of connector rise, and 6 feet of horizontal length. The common vent consists of a 30-foot height of Type B vent. What are the recommended vent diameters for each connector and the common vent? The installer would like to use a single-wall metal vent connector. See **Figure 10**.

#### Solution (Table 4)

**Water Heater Vent Connector Diameter:** Since the water heater vent connector horizontal length of 4 feet is less than the maximum value listed in **Paragraph 2, Page 12**, the venting table values can be used without adjustments. Using the Vent Connector Capacity portion of **Table 4**, read down the Total Vent Height (H) column to 30 feet and read across the 2-foot Connector Rise (R) row to the first Btu/hour rating in the NAT Max column that is equal to or greater than the water heater input rating. The table shows that a 3-inch vent connector has a maximum input rating of 37,000 Btu/hour. Although this rating is greater than the water heater input rating, a 3-inch vent connector is prohibited by 10.2.19. A 4-inch vent connector has a maximum input rating of 67,000 Btu/hour and is equal to the draft hood outlet diameter. A 4-inch vent connector is selected. Since the water heater is equipped with a draft hood, there are no minimum input rating restrictions.

**Furnace Vent Connector Diameter:** Using the Vent Connector Capacity portion of **Table 4**, read down the Total Vent Height (H) column to 30 feet and across the 3-foot Connector Rise (R) row. Since the furnace has a fan-assisted combustion system, find the first FAN Max column with a Btu/hour rating greater than the furnace input rating. The 4-inch vent connector has a maximum input rating of 119,000 Btu/hour and a minimum input rating of 85,000 Btu/hour.

The 100,000-Btu/hour furnace in this example falls within this range, so a 4-inch connector is adequate. Since the furnace vent connector horizontal length of 6 feet is less than the maximum value listed in **Paragraph 2, Page 12**, the venting table values can be used without adjustment. If the furnace had an input rating of 80,000 Btu/hour, then a Type B vent connector (see **Table 3**) would be needed in order to meet the minimum capacity limit.

**Common Vent Diameter:** The total input to the common vent is 135,000 Btu/hour. Using the Common Vent Capacity portion of **Table 4**, read down the Total Vent Height (H) column to 30 feet and across this row to find the smallest vent diameter in the FAN +NAT column that has a Btu/hour rating equal to or greater than 135,000 Btu/hour. The 4-inch common vent has a capacity of 132,000 Btu/hour, and the 5-inch common vent has a capacity of 202,000 Btu/hour. Therefore, the 5-inch common vent should be used in this example.

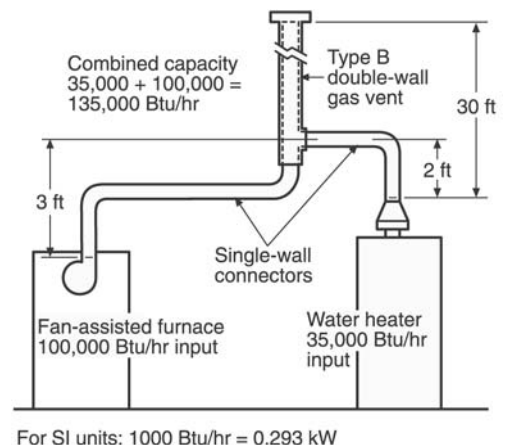

Figure 10

## **Examples Using Common Venting Tables** (continued)

**Summary:** In this example, the installer can use a 4-inch diameter, single-wall metal vent connector for the water heater and a 4-inch diameter, single-wall metal vent connector for the furnace. The common vent should be a 5-inch diameter Type B vent.